

# WARM AIR HEATING CONTROLS

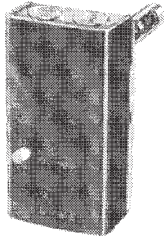

L4064

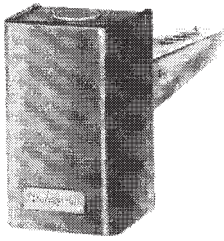

L4069

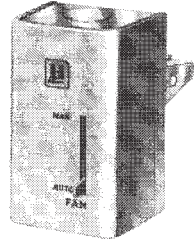

L4068

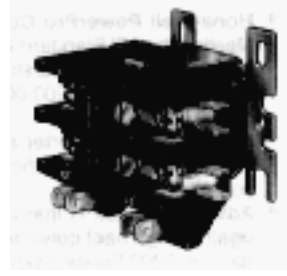

DP2040

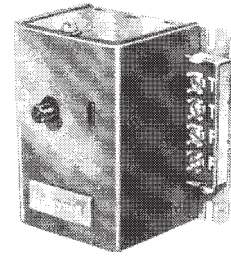

R8184

## FAN & LIMIT CONTROLS

DESCRIPTION	Unit	Qty.	Price
L4068E 1047 Fan Control - 3" Insertion Includes Case & Cover	Each	1	
L4068E 1054 Fan Control - 7" Insertion Includes Case & Cover	Each	1	
L4069A 1060 Limit Control - 7" Insertion	Each	1	
L4069A 1078 Limit Control - 3" Insertion	Each	1	
L4064W 1098 Comb. Fan & Limit 8" Insertion - With Bimetal Heater	Each	1	
L4064W 1106 Comb. Fan & Limit 11" Insertion - With Bimetal Heater	Each	1	
L4064B 1451 Comb. Fan & Limit - 11" Insertion	Each	1	
L4064B 1469 Comb. Fan & Limit - 5" Insertion	Each	1	
L4064B 2236 Comb. Fan & Limit - 8" Insertion	Each	1	

## HONEYWELL RELAYS & CONTACTORS

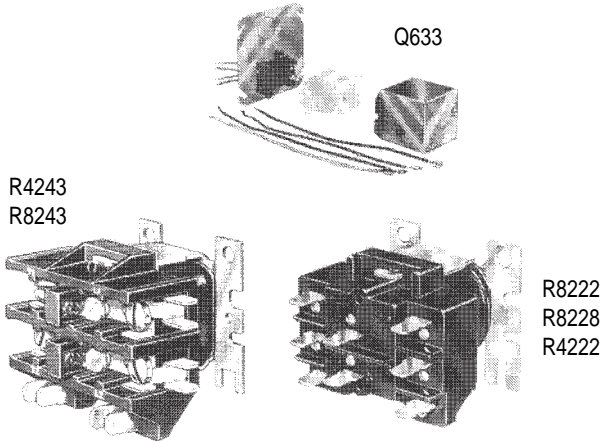

R4243  
R8243

Q633

R8222  
R8228  
R4222

DESCRIPTION	Unit	Qty.	Price
R847A1085 H.D.Relay & Trans. With Enclosure & 24 Volt Transformer	Each	1	
Q633A 1007 Relay Adapter Plate	Each	1	

## HONEYWELL RELAYS & CONTACTORS

DESCRIPTION	Unit	Qty.	Price
R8225A 1017 Fan Relay 24V - SPDT - With 1/2" Conduit Mount	Each	1	
R8222D 1014 General Purp.Relay 24V - DPDT - 2 Sets of 1 NO & 1 NC Contacts	Each	1	
R8222B 1067 General Purp.Relay 24V - SPDT	Each	1	
R4222D 1013 General Purp.Relay 120V DPDT - 2 Sets of 1 NO & 1 NC Contacts	Each	1	
R8228B 1012 H.D. Switching Relay 24V - SPDT - 1 NO Contact, 1 NC Contact	Each	1	
R4228B 1037 H.D. Switching Relay 120V - SPDT	Each	1	
R4228B 1045 H.D. Switching Relay 208/240V - SPDT	Each	1	
R8239B 1043 Relay & Trans. Kit 110V/24V 40VA Transformer DPDT Relay - 2 Sets of 1 NO & 1 NC Contact 4 x 4 Mounting Plate	Each	1	
R8239A 1052 Relay & Trans. Kit 110V/24V 40VA Transformer SPDT Relay - 1 NO Contact & 1 NC Contact 4 x 4 Mounting Plate	Each	1	
R8243B 1013 Contactor 24V/30 Amp - 2 Pole	Each	1	
R4243B 1038 Contactor 120V/30 Amp. - 2 Pole	Each	1	
R4243B 1046 Contactor 240V/30 Amp. - 2 Pole	Each	1	
DP2040A 5003 Contactor 24V/40 Amp. - 2 Pole	Each	1	

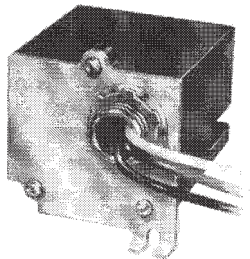

R8225

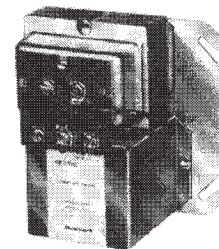

R8239