

MALCO DRILLS

Sheet Metal Drill Sets

10 PIECE SET

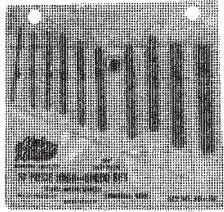

15 PIECE SET

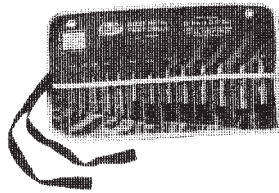

FS1525

Jobber Drill Sets

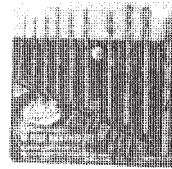

FJ10S

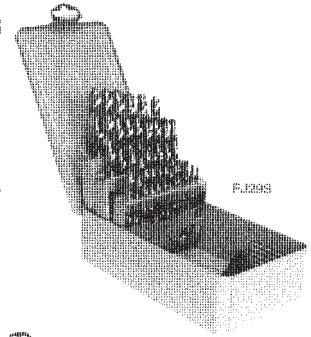

FJ20S

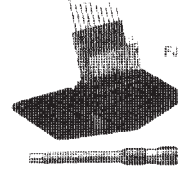

FJ6180

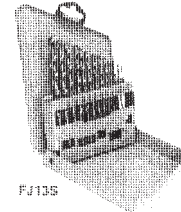

FJ10S

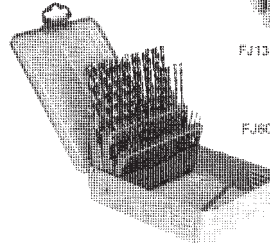

FJ60S

MALCO DRILL SETS

DESCRIPTION	Unit	Qty.	Price
FJ60S - 60 Piece Set Jobber Length Wire Drills #1 to #60 - With Drildex Container			
FJ 60S Drill Bit Set	Each	1	
FS10S - 10 Piece Set Sheet Metal (Stub Length) Drills 1/16;5/64;3/32;7/64;1/8;9/64;5/32;3/16;7/32;1/4 In Plastic Pouch			
FS 10S Drill Bit Set	Each	1	
FS1525 - 15 Piece Set Sheet Metal (Stub Length) Drills 1/16 to 1/2 by 32nds - Drills over 1/4" Have 1/4" Shanks In Plastic Pouch			
FS 1525 Drill Bit Set	Each	1	

ORIFICE DRILL SET

Wire gauge sizes for drilling or cleaning oil and gas orifices.
Metal Drildex Container. Sizes 61 to 80. Includes Pin Vise.
FJ 6180 Orifice Drill Set

Each 1

HIGH SPEED DRILL BITS

DESCRIPTION	Unit	Qty.	Price
1/8" Drill - Jobber - 4"	Each	1	
	Pack	12	
	2- Pk.	24	
1/4" Drill - Jobber - 4"	Each	1	
	Pack	12	
	2- Pk.	24	

NFS BLACK NITRIDE DRILL BITS

DESCRIPTION	Unit	Qty.	Price
#41 Drill - Black Nitrided	Each	1	
	Pack	12	
	2- Pk.	24	
7/64" Drill-Black Nitrided	Each	1	
	Pack	12	
	2- Pk.	24	
1/8" Drill-Black Nitrided	Each	1	
	Pack	12	
	2- Pk.	24	

DESCRIPTION	Unit	Qty.	Price
#30 Drill-Black Nitrided	Each	1	
	Pack	12	
	2- Pk.	24	
3/16" Drill-Black Nitrided	Each	1	
	Pack	12	
	2- Pk.	24	
7/32" Drill-Black Nitrided	Each	1	
	Pack	12	
	2- Pk.	24	
1/4" Drill-Black Nitrided	Each	1	
	Pack	12	
	2-Pk.	24	

DOUBLE END DRILL BITS

DESCRIPTION	Unit	Qty.	Price
1/8" Double End Drill Bit	Each	1	
	Pack	12	
	2- Pk.	24	
#30 Double End Drill Bit	Each	1	
	Pack	12	
	2- Pk.	24	

BIT SAVERS

DESCRIPTION	Unit	Qty.	Price
B1 Bit Saver - .082 To .098	Each	1	
B2 Bit Saver - .109 To .129	Each	1	
B3 Bit Saver - .130 To .157	Each	1	

